





**EN Built-in Freezer - Fridge / User Manual**



## Thank you for choosing this product.

This user manual contains important information on safety and instructions intended to assist you in the operation and maintenance of your appliance.

Please take the time to read this user manual before using your appliance and keep this book for future reference.

Icon	Type	Meaning
	<b>WARNING</b>	Serious injury or death risk
	<b>RISK OF ELECTRIC SHOCK</b>	Dangerous voltage risk
	<b>FIRE</b>	Warning; Risk of fire / flammable materials
	<b>CAUTION</b>	Injury or property damage risk
	<b>IMPORTANT</b>	Operating the system correctly

# SAFETY INSTRUCTIONS IMPORTANT TO BE READ AND OBSERVED

---

Before using the appliance, read these safety instructions. Keep them nearby for future reference. These instructions and the appliance itself provide important safety warnings, to be observed at all times. The manufacturer declines any liability for failure to observe these safety instructions, for inappropriate use of the appliance or incorrect setting of controls.

⚠ Very young children (0-3 years) should be kept away from the appliance. Young children (3-8 years) should be kept away from the appliance unless continuously supervised. Children from 8 years old and above and persons with reduced physical, sensory or mental capabilities or lack of experience and knowledge can use this appliance only if they are supervised or have been given instructions on safe use and understand the hazards involved. Children must not play with the appliance. Cleaning and user maintenance must not be carried out by children without supervision.

Children aged from 3 to 8 years are allowed to load and unload refrigerating appliances.

## PERMITTED USE

⚠ CAUTION: The appliance is not intended to be operated by means of an external switching device, such as a timer, or separate remote controlled system.

⚠ This appliance is intended to be used in household and similar applications such as: staff kitchen areas in shops, offices and other working environments; farm houses; by clients in hotels, motels, bed & breakfast and other residential environments.

⚠ This appliance is not for professional use. Do not use the appliance outdoors.

⚠ The bulb used inside the appliance is specifically designed for domestic appliances and is not suitable for general room lighting within the home (EC Regulation 244/2009).

⚠ The appliance is designed for operation in places where the ambient temperature comes within the following ranges, according to the climatic class given on the rating plate. The appliance may not work properly if it is left for a long time at a temperature outside the specified range.

Climatic class ambient temperatures:

SN: From 10°C to 32°C ;

N: From 16°C to 32°C

ST: From 16°C to 38°C ;

T: From 16°C to 43°C .



This appliance does not contain CFCs. The refrigerant circuit contains R600a (HC). Appliances with Isobutane (R600a):

isobutane is a natural gas without environmental impact, but is flammable.

Therefore, make sure the refrigerant circuit pipes are not damaged, especially when emptying the refrigerant circuit.

**⚠ WARNING:** Do not damage the appliance refrigerant circuit pipes.

**⚠ WARNING:** Keep ventilation openings, in the appliance enclosure or in the built-in structure, clear of obstruction.

**⚠ WARNING:** Do not use mechanical, electric or chemical means other than those recommended by the Manufacturer to speed up the defrost process.

**⚠ WARNING:** Do not use or place electrical devices inside the appliance compartments if they are not of the type expressly authorised by the Manufacturer.

**⚠ WARNING:** Ice makers and/or water dispensers not directly connected to the water supply must be filled with potable water only.

**⚠ WARNING:** Automatic ice-makers and/or water dispensers must be connected to a water

supply that delivers potable water only, with mains water pressure between 0.17 and 0.81 MPa (1.7 and 8.1 bar).

**⚠** Do not store explosive substances such as aerosol cans and do not place or use gasoline or other flammable materials in or near the appliance.

**⚠** Do not swallow the contents (non-toxic) of the ice packs (provided with some models). Do not eat ice cubes or ice lollies immediately after taking them out of the freezer since they may cause cold burns.

**⚠** For products designed to use an air filter inside an accessible fan cover, the filter must always be in position when the refrigerator is in function.

**⚠** Do not store glass containers with liquids in the freezer compartment since they may break.

Do not obstruct the fan (if included) with food items.

After placing the food check that the door of compartments closes properly, especially the freezer door.

**⚠** Damaged gaskets must be replaced as soon as possible.

**⚠** Use the refrigerator compartment only for storing fresh food and the freezer compartment only for storing frozen food, freezing fresh food and making ice cubes.

**⚠** Avoid storing unwrapped food

in direct contact with internal surfaces of the refrigerator or freezer compartments.

Appliances could have special compartments (Fresh Food Compartment, Zero Degree Box,...).

Unless differently specified in the specific booklet of product, they can be removed, maintaining equivalent performances.



C-Pentane is used as blowing agent in the insulation foam and it is a flammable gas.

The most appropriate compartments of the appliance where specific types of food are to be stored, taking into account different temperature distribution in different compartments in the appliance, are as follows:

- Refrigerator compartment:

1) Upper area of the refrigerator compartment & door - temperature zone: Store tropical fruit, cans, drinks, eggs, sauces, pickles, butter, jam

2) Middle area of the refrigerator compartment - cool zone: Store cheese, milk, dairy food, deli food, yoghurt

3) Lower area of the refrigerator compartment - coldest zone: Store cold cuts, desserts, meat and fish, cheesecake, fresh pasta, sour cream, pesto/salsa, home-cooked food, pastry cream, pudding and cream cheese

4) Fruit & vegetable drawer at the bottom of the refrigerator

compartment: Store vegetables and fruits (excluding tropical fruits)

5) Chiller compartment: Only store meat and fish in the coldest drawer

- Freezer compartment:

4 star zone (\*\*\*\*) compartment is suitable for freezing foodstuffs from ambient temperature and for storing frozen food as the temperature is evenly distributed throughout the entire compartment.

Purchased frozen food has the storage expiration date stated on the packaging. This date takes into account the type of food being stored and therefore this date should be respected. Fresh food should be stored for the following time periods: 1-3 months for cheese, shellfish, ice cream, ham/sausage, milk, fresh liquids; 4 months for steak or chops (beef, lamb, pork); 6 months for butter or margarine, poultry (chicken, turkey); 8-12 months for fruits (except citrus), roast meat (beef, pork, lamb), vegetables. Expiration dates on the packaging of foods in the 2-star zone must be respected.

To avoid food contamination, please observe the following:

- Opening the door for long periods can cause a significant increase of the temperature in the compartments of the appliance.

- Regularly clean surfaces that

may come into contact with food and accessible drainage systems.

– Clean water tanks if they have not been used for 48 h; flush the water system connected to a water supply if water has not been drawn for 5 days.

– Store raw meat and fish in suitable containers in the refrigerator, so that it does not come into contact with or drip onto other food.

– Two-star frozen food compartments are suitable for storing pre-frozen food, storing or making ice cream and ice cubes.

– Do not freeze fresh food in one, two or three-star compartments.

– If the refrigerating appliance is left empty for long periods, switch off, defrost, clean, dry, and leave the door open to prevent mould developing inside the appliance.

## **INSTALLATION**

⚠ The appliance must be handled and installed by two or more persons - risk of injury. Use protective gloves to unpack and install - risk of cuts.

⚠ Installation, including water supply (if any), electrical connections and repairs must be carried out by a qualified technician. Do not repair or replace any part of the appliance unless specifically stated in the user manual. Keep children away from the installation site. After unpacking the appliance, make sure that it has not been damaged

during transport. In the event of problems, contact the dealer or your nearest After-sales Service. Once installed, packaging waste (plastic, styrofoam parts etc.) must be stored out of reach of children - risk of suffocation. The appliance must be disconnected from the power supply before any installation operation - risk of electrical shock.

During installation, make sure the appliance does not damage the power cable - risk of fire or electrical shock. Only activate the appliance when the installation has been completed.

⚠ Be careful not to damage the floors (e.g. parquet) when moving the appliance. Install the appliance on a floor or support strong enough to take its weight and in a place suitable for its size and use. Make sure the appliance is not near a heat source and that the four feet are stable and resting on the floor, adjusting them as required, and check that the appliance is perfectly level using a spirit level. Wait at least two hours before switching the appliance on, to ensure that the refrigerant circuit is fully efficient.

⚠ **WARNING:** When positioning the appliance, ensure the supply cord is not trapped or damaged.

⚠ **WARNING:** To avoid a hazard due to instability, positioning or fixing of the appliance must be done in accordance with the

manufacturer instructions.  
It's forbidden to place the refrigerator in such way that the metal hose of gas stove, metal gas or water pipes, or electrical wires are in contact with the refrigerator back wall (condenser coil).

All dimensions and spacing needed for installation of the appliance are in the Installation Instruction booklet.

Please remove the power cord from condenser hook during installation before connecting product to power supply.

### **ELECTRICAL WARNINGS**

⚠ It must be possible to disconnect the appliance from the power supply by unplugging it if plug is accessible, or by a multi-pole switch installed upstream of the socket in accordance with the wiring rules and the appliance must be earthed in conformity with national electrical safety standards.

⚠ Do not use extension leads, multiple sockets or adapters. The electrical components must not be accessible to the user after installation. Do not use the appliance when you are wet or barefoot.

Do not operate this appliance if it has a damaged power cable or plug, if it is not working properly, or if it has been damaged or dropped.

⚠ If the supply cord is damaged,

it must be replaced with an identical one by the manufacturer, its service agent or similarly qualified persons in order to avoid a hazard - risk of electrical shock.

⚠ **WARNING:** Do not locate multiple portable socket-outlets or portable power supplies at the rear of the appliance.

### **CLEANING AND MAINTENANCE**

⚠ **WARNING:** Ensure that the appliance is switched off and disconnected from the power supply before performing any maintenance operation. To avoid risk of personal injury use protective gloves (risk of laceration) and safety shoes (risk of contusion); be sure to handle by two persons (reduce load); never use steam cleaning equipment (risk of electric shock). Non-professional repairs not authorised by the manufacturer could result in a risk to health and safety, for which the manufacturer cannot be held liable. Any defect or damage caused from non-professional repairs or maintenance will not be covered by the guarantee, the terms of which are outlined in the document delivered with the unit.

⚠ Do not use abrasive or harsh cleaners such as window sprays, scouring cleansers, flammable fluids, cleaning waxes, concentrated detergents, bleaches or cleansers containing petroleum products on plastic



parts, interior and door liners or gaskets. Do not use paper towels, scouring pads, or other harsh cleaning tools.

## **DISPOSAL OF PACKAGING MATERIALS**

The packaging material is 100% recyclable and is marked with the recycle symbol . The various parts of the packaging must therefore be disposed of responsibly and in full compliance with local authority regulations governing waste disposal.

## **DISPOSAL OF HOUSEHOLD APPLIANCES**

This appliance is manufactured with recyclable or reusable materials.

Dispose of it in accordance with local waste disposal regulations.

For further information on the treatment, recovery and recycling of household electrical appliances, contact your local authority, the collection service for household waste or the store where you purchased the appliance. This appliance is marked in compliance with European Directive 2012/19/EU, Waste Electrical and Electronic Equipment (WEEE) and with the Waste Electrical and Electronic Equipment regulations 2013 (as amended). By ensuring this product is disposed of correctly, you will help prevent negative consequences for the environment and human health.

The  symbol on the product or on the accompanying documentation indicates that it should not be treated as domestic waste but must be taken to an appropriate collection center for the recycling of electrical and electronic equipment.

## **ENERGY SAVING TIPS**

To guarantee adequate ventilation follow installation instructions.

Insufficient ventilation at the back of the product increases energy consumption and decreases cooling efficiency.

Frequent door opening might cause an increase in Energy Consumption.

The internal temperature of the appliance and the Energy Consumption may be affected also by the ambient temperature, as well as location of the appliance. Temperature setting should take into consideration these factors. Reduce door opening to minimum.

When thawing frozen food, place it in the refrigerator. The low temperature of the frozen products cools the food in the refrigerator.

Allow warm food and drinks to cool down before placing in the appliance.

Positioning of the shelves in the refrigerator has no impact on the efficient usage of energy. Food should be placed on the shelves in such way to ensure proper air circulation (food should not touch each other and distance between food and rear wall should be kept).

You can increase storage capacity of frozen food by removing baskets and, if present, Stop Frost shelf.

Do not worry about noises coming from the compressor which are normal operation noises. This product contains a light source of energy efficiency class E.



# 1 DESCRIPTION OF THE APPLIANCE

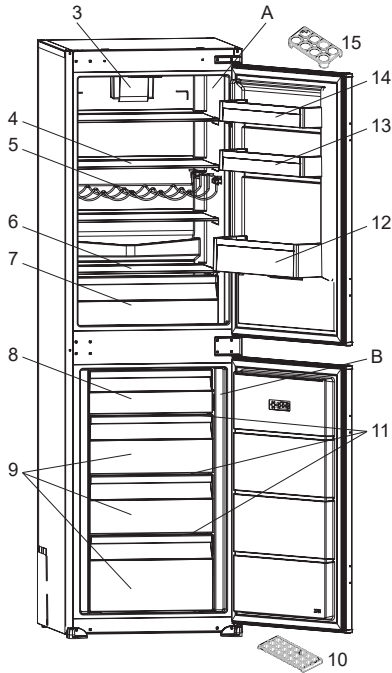
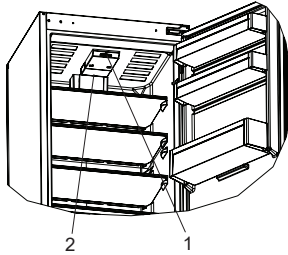

- A) Refrigerator compartment
- B) Freezer compartment
- 1) Thermostat knob
- 2) Lamp cover
- 3) Turbo fan \*
- 4) Refrigerator shelves
- 5) Wine rack \*
- 6) Crisper cover
- 7) Crisper
- 8) Freezer upper flap / Drawer
- 9) Freezer drawers
- 10) Ice box tray
- 11) Freezer glass shelves\*
- 12) Bottle shelf
- 13) Adjustable door shelf \* / Door shelf
- 14) Door shelf
- 15) Egg holder

\* In some models

 This presentation is only for information about the parts of the appliance. Parts may vary according to the appliance model.

## 2 USING THE APPLIANCE

### 2.1 Information on the Frost Free Technology

The Frost Free refrigerators have a different operating system to static refrigerators.

In normal (static) fridges, the humidity entering the fridge due to opening the door, and the humidity inherent in the food, causes frost build-up in the freezer compartment.

To defrost the frost and ice in the freezer compartment, you are required to periodically switch off the fridge, place the frozen food in a separate cooled container, then remove the ice gathered in the freezer compartment.

The situation is completely different in No-frost fridges. A built-in fan blows dry and cold air evenly throughout the cooler and freezer compartments. The cold air disperses uniformly between the shelves, ensuring all your food is cooled equally, thus preventing humidity and frost build-up.

Therefore, your No-frost fridge allows ease of use, in addition to its huge capacity and stylish appearance.

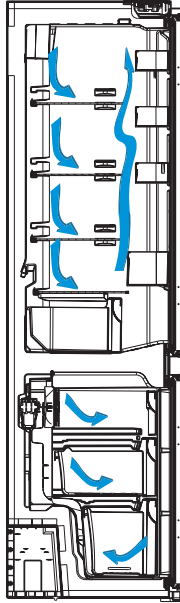

### 2.2 Thermostat Setting

The thermostat automatically regulates the temperature inside the refrigerator and freezer compartments. Cooler temperatures can be obtained by rotating the knob to higher numbers, 1 to 5.

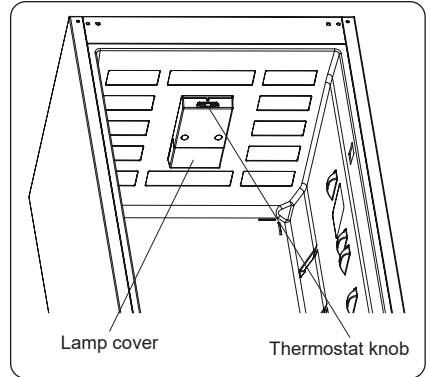

#### Thermostat Settings

- Set the knob to a low/medium position, up to 3, for short-term storage of food in the appliance.
- Set the knob to a medium position, 3 or 4, for long-term storage of food in the appliance.
- Set the knob to 5 position for freezing the fresh food. The appliance will run for colder temperatures.

#### 2.3 Temperature Adjustment Warnings

- It is not recommended that you operate your fridge in environments colder than 10°C in terms of its efficiency.
- Temperature adjustments should be made according to the frequency of door openings, the quantity of food kept inside the fridge and the ambient temperature in the location of your fridge.
- In order to allow your fridge to reach the operating temperature after being connected to mains, do not open the doors frequently or place large quantities of food in the fridge. Please note that, depending on the ambient temperature, it may take 24 hours for your fridge to reach the operating temperature.

- A 5 minute delay function is applied to prevent damage to the compressor of your fridge when connecting or disconnecting to mains, or when an energy breakdown occurs. Your fridge will begin to operate normally after 5 minutes.
- Your appliance is designed to operate in the ambient temperature (T/N = 16°C - 43°C) intervals stated in the standards, according to the climate class displayed on the information label. We do not recommend operating your appliance out of the stated temperature limits in terms of cooling effectiveness.

Climate Class	Ambient Temperature °C
T	Between 16 and 43 (°C)
ST	Between 16 and 38 (°C)
N	Between 16 and 32 (°C)
SN	Between 10 and 32 (°C)

### The Turbo Fan (if available)

Do not block the air inlet and outlet openings when storing food, otherwise air circulation provided by the turbo fan will be impaired.

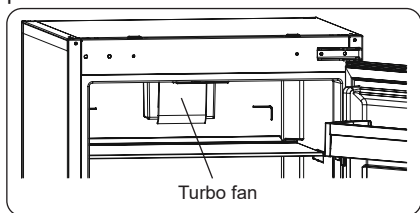

## 2.4 Accessories

**Visual and text descriptions in the accessories section may vary according to the model of your appliance.**

### 2.4.1 Ice Tray (In some models)

- Fill the ice tray with water and place in the freezer compartment.
- After the water has completely frozen, you can twist the tray as shown below to remove the ice cubes.

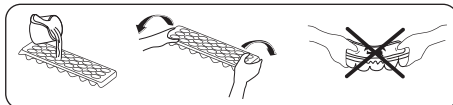

### 2.4.2 The Bottle Holder (In some models)

Use the bottle holder to prevent bottles from slipping or falling over.

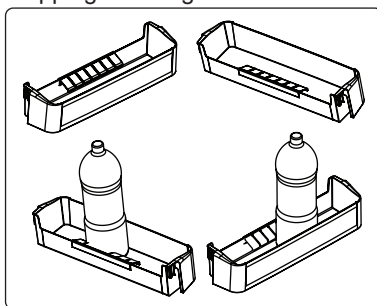

### 2.4.3 The Fresh Dial (In some models)

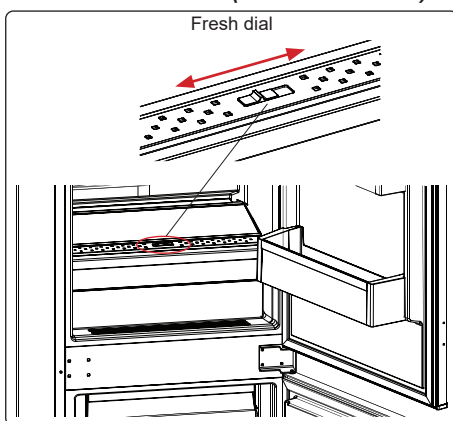

If the crisper is full, the fresh dial located in front of the crisper should be opened. This allows the air in the crisper and the humidity rate to be controlled, to increase the life of food within.

The dial, located behind the shelf, must be opened if any condensation is seen on the glass shelf.

#### 2.4.4 Adjustable Door Shelf (In some models)

Six different height adjustments can be made to provide storage areas that you need by adjustable door shelf.

To change the position of adjustable door shelf ;

Hold the bottom of the shelf and pull the buttons on the side of the door shelf direction of arrow.

(Fig.1)

Position door shelf the height you need by moving up and down. After you get the position that you want the door shelf, release the buttons on the side of the door shelf (Fig.2) Before releasing the door shelf, move up down and make sure the door shelf is fixed.

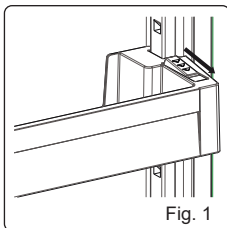

Fig. 1

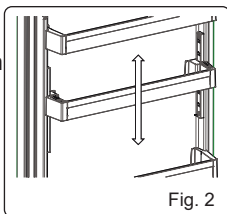



Fig. 2

 **Note:** Before moving door shelf is loaded, you must hold the shelf by supporting the bottom. Otherwise, door shelf could fall off the rails due to the weight. So damage may occur on the door shelf or rails.

#### 2.4.5 Maxi-fresh preserver (if available)

Maxi Fresh Preserver technology helps to remove ethylene gas (a bioproduct released naturally from fresh foods) and unpleasant odors from the crisper. In this way, food stays fresh for a longer time.

- Maxi Fresh Preserver must be cleaned once in a year. The filter should be waited for 2 hours at 65°C in a oven.
- To clean the filter, please remove the back cover of the filter box by pulling it in the direction of the arrow.
- The filter should not be washed with water or any detergent.

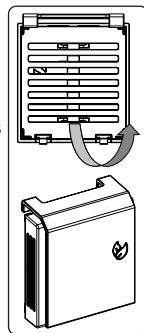

Maxi Fresh Preserver  
(In some models)

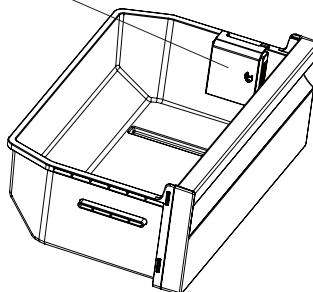

## 3 FOOD STORAGE

### 3.1 Refrigerator Compartment

- To reduce humidity and avoid the consequent formation of frost, always store liquids in sealed containers in the refrigerator. Frost tends to concentrate in the coldest parts of the evaporating liquid and, in time, your appliance will require more frequent defrosting.
- Never place warm food in the refrigerator. Warm food should be allowed to cool at room temperature and should be arranged to ensure adequate air circulation in the refrigerator compartment.
- Make sure no items are in direct contact with the rear wall of the appliance as frost will develop and packaging will stick to it. Do not open the refrigerator door frequently.
- We recommend that meat and clean fish are loosely wrapped and stored on the glass shelf just above the vegetable bin where the air is cooler, as this provides the best storage conditions.
- Store loose fruit and vegetable items in the crisper containers.
- Store loose fruit and vegetables in the crisper.
- Storing fruit and vegetables separately helps prevent ethylene-sensitive vegetables (green leaves, broccoli, carrot, etc.) being affected by ethylene-releaser fruits (banana, peach, apricot, fig etc.).
- Do not put wet vegetables into the refrigerator.
- Storage time for all food products depends on the initial quality of the food and an uninterrupted refrigeration cycle before refrigerator storage.
- To avoid cross-contamination do not store meat products with fruit and vegetables. Water leaking from meat may contaminate other products in the refrigerator. You should package meat

products and clean any leakages on the shelves.

- Do not put food in front of the air flow passage.
- Consume packaged foods before the recommended expiry date.



**NOTE:** Potatoes, onions and garlic should not be stored in the refrigerator.

### 3.2 Freezer Compartment

- The freezer is used for storing frozen food, freezing fresh food, and making ice cubes.
- For freezing fresh food; wrap and seal fresh food properly, that is the packaging should be air tight and shouldn't leak. Special freezer bags, aluminum foil polythene bags and plastic containers are ideal.
- Do not store fresh food next to frozen food as it can thaw the frozen food.
- Before freezing fresh food, divide it into portions that can be consumed in one sitting.
- Consume thawed frozen food within a short period of time after defrosting
- Never place warm food in the freezer compartment as it will thaw the frozen food.
- Always follow the manufacturer's instructions on food packaging when storing frozen food. If no information is provided food, should not be stored for more than 3 months from the date of purchase.
- When purchasing frozen food, make sure that it has been stored under appropriate conditions and that the packaging is not damaged.
- Frozen food should be transported in appropriate containers and placed in the freezer as soon as possible.
- Do not purchase frozen food if the packaging shows signs of humidity and abnormal swelling. It is probable that it has been stored at an unsuitable temperature and that the contents have deteriorated.

- The storage life of frozen food depends on the room temperature, the thermostat setting, how often the door is opened, the type of food, and the length of time required to transport the product from the shop to your home. Always follow the instructions printed on the packaging and never exceed the maximum storage life indicated.
- The maximum amount of fresh food (in kg) that can be frozen in 24 hours is indicated on the appliance label.
- To use the maximum capacity of the freezer compartment, use the glass shelves for the upper and middle section, and use the lower basket for the bottom section.
- Use the fast freezing shelf to freeze home cooking (and any other food which needs to be frozen quickly) more quickly because of the freezing shelf's greater freezing power. Fast freezing shelf is the bottom drawer of the freezer compartment.

**NOTE:** If you attempt to open the freezer door immediately after closing it, you will find that it will not open easily. This is normal. Once equilibrium has been reached, the door will open easily.

**Important note:**



- Never refreeze thawed frozen food.
- The taste of some spices found in cooked dishes (anise, basilica, watercress, vinegar, assorted spices, ginger, garlic, onion, mustard, thyme, marjoram, black pepper, etc.) changes and they assume a strong taste when they are stored for a long period of time. Therefore, add small amounts of spices to food to be frozen, or the desired spice should be added after the food has thawed.
- The storage time of food is dependent on the type of oil used. Suitable oils are margarine, calf fat, olive oil and butter. Unsuitable oils are peanut oil and pig fat.
- Food in liquid form should be frozen in plastic cups and other food should be frozen in plastic folios or bags.

FROZEN COMPARTMENT			
Product	Storage period (-12°C)	Recommended Storage period (-18°C)	Storage period (-24°C)
Butter or margarine	1 month	6 months	9 months
Fish	1 month	1-3 months	6 months
Fruits (except citrus) & Vegetables	1 month	8-12 months	12 months
Meat- Ham- sausage Roasts (beef-pork- lamb) Steaks or chops (beef- lamb-pork)	1 month	2 months 8-12 months 4 months	12 months
Milk, Fresh fluid, Cheese, Ice cream or sherbet	1 month	1-3 months	5 months (not recommended for ice cream)
Poultry (chicken-turkey)	1 month	5-7 months	9 months

UNFROZEN COMPARTMENT			
Product	Storage period (0-3°C)	Storage period (3-6°C)	Storage period (6-8°C)
Cans, drinks, eggs, sauces, pickles, butter, jam	3-4 weeks	3-4 weeks	3-4 weeks
Tropical fruit	Not recommended	2-4 weeks	3-4 weeks
Cheese, milk, dairy food, deli food, yoghurt	2-5 days	2-5 days	2-5 days
Cold cuts, desserts, meat and fish and homecooked food	3-5 days	1-2 days	Not recommended
Store vegetables and fruits (excluding tropical fruits and citrus)	15 days	10-12 days	4-7 days



## 4 CLEANING AND MAINTENANCE

-  Disconnect the unit from the power supply before cleaning.
-  Do not wash your appliance by pouring water on it.
-  Do not use abrasive products, detergents or soaps for cleaning the appliance. After washing, rinse with clean water and dry carefully. When you have finished cleaning, reconnect the plug to the mains supply with dry hands.

- Make sure that no water enters the lamp housing and other electrical components.
- The appliance should be cleaned regularly using a solution of bicarbonate of soda and lukewarm water.
- Clean the accessories separately by hand with soap and water. Do not wash accessories in a dish washer.
- Clean the condenser with a brush at least twice a year. This will help you to save on energy costs and increase productivity.

  **The power supply must be disconnected during cleaning.**

### 4.1 Defrosting

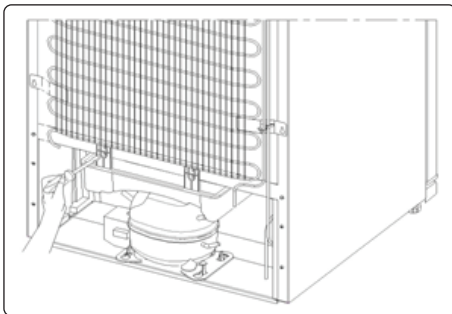

- Your appliance performs automatic defrosting. The water formed as a result of defrosting passes through the water collection spout, flows into the water tray

behind your appliance and evaporates there.

- Make sure you have disconnected the plug of your appliance before cleaning the water tray.
- Remove the water tray from its position by removing the screws as indicated. Clean it with soapy water at specific time intervals. This will prevent odours from forming.

### 4.2 Replacing the Light Bulb

 **Important note:** Unplug the unit from the power supply before start the process.

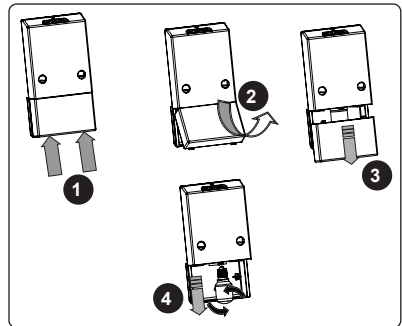

1. Press the hooks on light cover. (Fig. 1)
2. Open the light cover towards arrow when top hooks pull out from housing. (Fig. 2)
3. Pull out the cover towards arrow remove it. (Fig. 3)
4. Turn the light bulb counter clockwise and remove it. (Fig. 4)
5. Change the present light bulb with a new one of not more than 15 W. (Fig. 4)
6. Implement the steps in reverse order.
7. After waiting 5 minutes, plug the unit.

### Replacing LED Lighting

 If your appliance has LED lighting contact the help desk as this should be changed by authorized personnel only.

## 5 SHIPMENT AND REPOSITIONING

### 5.1 Transportation and Changing Positioning

- The original packaging and foam may be kept for re-transportation (optional).
- Fasten your appliance with thick packaging, bands or strong cords and follow the instructions for transportation on the packaging.
- Remove all movable parts (shelves, accessories, vegetable bins, and so on) or fix them into the appliance against shocks using bands when re-positioning or transporting.

 Always carry your appliance in the upright position.

## 6 BEFORE CALLING AFTER-SALES SERVICE

If you are experiencing a problem with your refrigerator, please check the following before contacting the after-sales service.

**Your refrigerator does not operate**

**Check if:**

- Your fridge is plugged in and switched on
- The fuse has blown
- The thermostat setting is on position '1'
- The socket is faulty. To check this, plug another working appliance into the same socket.

**Your refrigerator is performing poorly**

**Check if:**

- The appliance is overloaded
- The doors are closed properly
- There is any dust on the condenser
- There is an adequate distance between the appliance and surrounding walls

**Your refrigerator is operating noisily**

The following noises can be heard during normal operation of the appliance.

**Cracking (ice cracking) noise occurs:**

- During automatic defrosting.
- When the appliance is cooled

or warmed (due to expansion of appliance material).

**Clicking noise occurs:** When the thermostat switches the compressor on/off.

**Motor noise:** Indicates the compressor is operating normally. The compressor may cause more noise for a short time when it is first activated.

**Bubbling noise and splashing occurs:** Due to the flow of the refrigerant in the tubes of the system.

**Water flowing noise occurs:** Due to water flowing to the evaporation container. This noise is normal during defrosting.

**Air blowing noise occurs:** During normal operation of the system due to the circulation of air.

**There is a build-up of humidity inside the fridge**

**Check if:**

- All food is packed properly. Containers must be dry before being placed in the fridge.
- The fridge doors are opened frequently. Humidity of the room will enter the fridge each time the doors are opened. Humidity increases faster if the doors are opened frequently, especially if the humidity of the room is high.
- There is a build-up of water droplets on the rear wall. This is normal after automatic defrosting (in Static Models).

**The doors are not opening or closing properly**

**Check if:**

- There is food or packaging preventing the door from closing
- The door compartments, shelves and drawers are placed properly
- The door gaskets are broken or torn
- Your fridge is level.

**The edges of the fridge in contact with the door joint are warm**

Especially during summer (warm weather), the surfaces in contact with the door joint

may become warmer during operation of the compressor. This is normal.

### **Important Notes:**

- In the case of a power failure, or if the appliance is unplugged and plugged in again, the gas in the cooling system of your refrigerator will destabilise, causing the compressor protective thermal element to open. Your refrigerator will start to operate normally after 5 minutes.
- If the appliance will not be used for a long period of time (such as during holidays), disconnect the plug. Defrost and clean the refrigerator, leaving the door open to prevent the formation of mildew and odour.
- If the problem persists after you have followed all the instructions above, please consult the nearest Authorised Service Centre.
- This appliance is designed for domestic use and for the stated purposes only. It is not suitable for commercial or common use. If the consumer uses the appliance in a way that does not comply with these instructions, we emphasise that the manufacturer and the dealer will not be responsible for any repair or failure within the guarantee period.

## **7 TIPS FOR SAVING ENERGY**

1. Install the appliance in a cool, well-ventilated room, but not in direct sunlight and not near a heat source (such as a radiator or oven) otherwise an insulating plate should be used.
2. Allow warm food and drinks to cool before placing them inside the appliance.
3. Place thawing food in the refrigerator compartment. The low temperature of the frozen food will help cool the refrigerator compartment while the food is thawing. This will save energy. Frozen food left to thaw outside of the appliance will result in a waste of energy.
4. Drinks or other liquids should be covered when inside the appliance. If left uncovered, the humidity inside the

appliance will increase, therefore the appliance uses more energy. Keeping drinks and other liquids covered helps preserve their smell and taste.

5. Avoid keeping the doors open for long periods and opening the doors too frequently as warm air will enter the appliance and cause the compressor to switch on unnecessarily often.
6. Keep the covers of the different temperature compartments (such as the crisper and chiller) closed.
7. The door gasket must be clean and pliable. In case of wear, if your gasket is detachable, replace the gasket. If not detachable, you have to replace the door.

## 8 ECODESIGN LEAFLET - 2020

This list provides all Ecodesign requirements, if the requirement is applicable to your product.

The refrigerating appliance is not intended to be used as a built-in appliance, unless specifically shown as such into its instruction manual.

The drawers, baskets and shelves should be kept in their current position unless otherwise specified in this document.

Doors and lids of the refrigeration appliance should be removed before disposal in the landfill, to avoid children or animals getting trapped inside.

Recommended setting:

- Refrigerator compartment: +4°C or MED
- Freezer compartment: -18°C or -20°C

### **Fast Freeze (if available)**

The use of this function is recommended when placing a very high quantity of food to be frozen in the freezer compartment. 24 hours before freezing fresh food, press the Fast Freeze button to activate the Fast Freeze function. When activated, the Fast Freeze indicator turns on. After 24 hours place the food to be frozen in the freezing zone of freezer compartment. The function is automatically disabled after 72 hours, or can be manually disabled by pressing Fast Freeze button.

### **Fast Cool**

Using Fast Cool function it is possible to increase the cooling capacity in the refrigerator compartment. The use of this function is recommended when placing a very high quantity of food in the refrigerator compartment. Press the Fast Cool button to activate Fast Cool function. When activated, the Fast Cool indicator turns on.

The function is automatically disabled after 6 hours, or can be manually disabled by pressing Fast Cool button again.

To optimise freezing speed and get more storage space, the freezer compartment can be used without the freezer drawers.

The quantity of fresh food that can be frozen in a specific time period is indicated on the rating plate.

Load limits are determined by baskets, flaps, drawers, shelves etc. Make sure that these components can still close easily after loading.

To avoid food waste, please refer to the recommended setting and storage times found in the user manual.

### **Making ICE cubes**

Fill 2/3 of the ice tray with water and put it back in the freezer compartment. Do not, under any circumstances, use sharp or pointed objects to remove the ice.

The model information can be retrieved using the QR-Code indicated on the energy label.

The label also includes the model identifier that can be used to consult the <https://eprel.ec.europa.eu> database portal.

### **Defrosting the freezer compartment**

The freezer should be defrosted once or twice a year or when excessive frost is present (3 mm thickness). The formation of frost is normal. The amount and rate at which frost accumulates depends on room conditions and how often the door is open. To defrost the unit, switch off the product and take out all food. Leave the freezer door open to allow the frost to melt. Use the box under the bottom front of the appliance to collect water (showed on the figure). Clean the inside of the freezer. Rinse and dry thoroughly. Switch the appliance back on and store the food inside.

If the declaration for the "chiller/ chill" drawer is on the rating plate, the declaration applies only to standard EN 62552:2013, valid until February 28<sup>th</sup>, 2021.

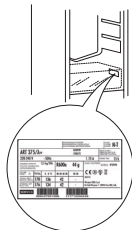

Automatic ice makers of the direct water connection type shall be connected in accordance with the instructions to a water supply having a temperature of 25 °C.

To fill the tank, lift the flap or remove the cover then pour in the water with a carafe or other suitable container. Avoid filling the tank completely.

This product contains a light source of energy efficiency class G (if present).





CE



5224xxxx

